

POLY FLEX DATA SHEET

PRODUCT: MOUNT **P-SYSTEM**[®]

SERIES: **5F GENSET SERIES**

MODEL: P#8.5F (5") 90-12-24 () GEN

MATERIAL SPECIFICATION	
<ul style="list-style-type: none"> ENGINEERING GRADE HEAT CURED POLYMER ALLOY ALL METAL PARTS - SA5 COBALT ZINC PLATED 	

CORE COLOUR	SHORE HARDNESS
ORANGE	50
BLUE	60
YELLOW	70
GREEN	80

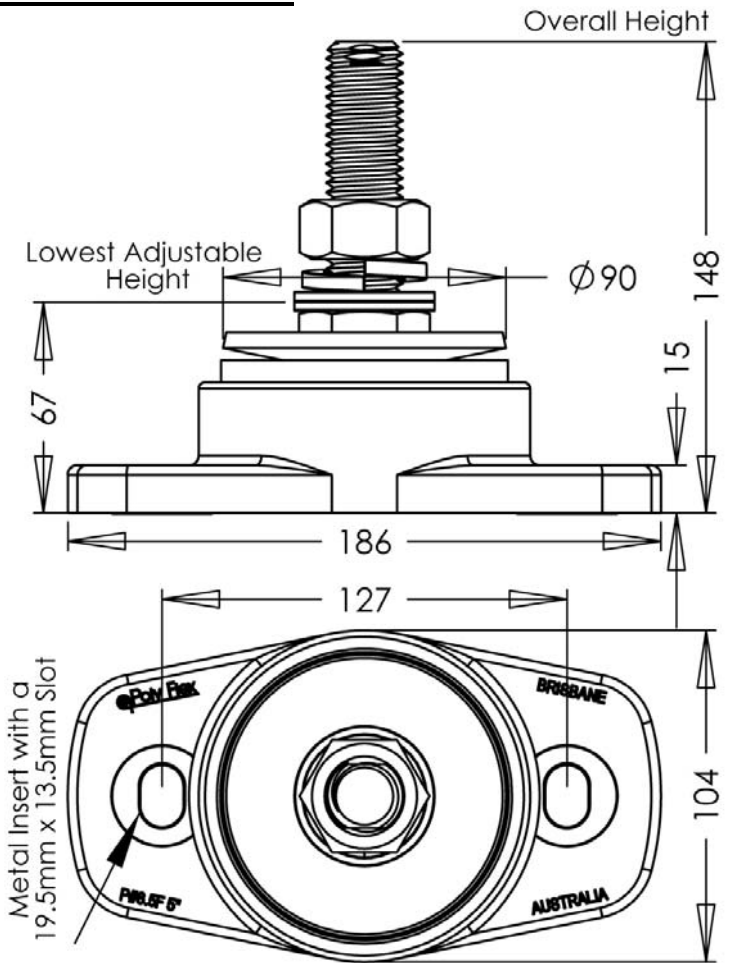

THE FOLLOWING DATA IS SUPPLIED AS A GUIDE ONLY. PRODUCT SPECIFICATIONS AND DATA SHEETS ARE SUBJECT TO CHANGE WITHOUT NOTICE.

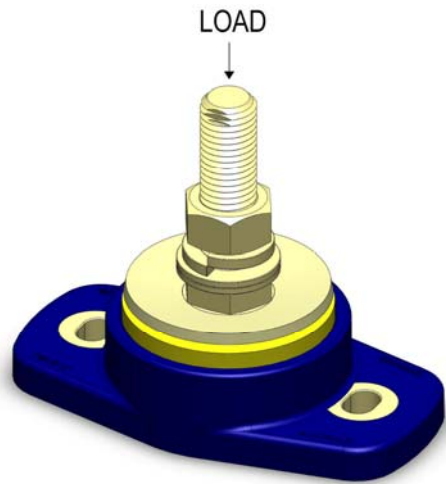
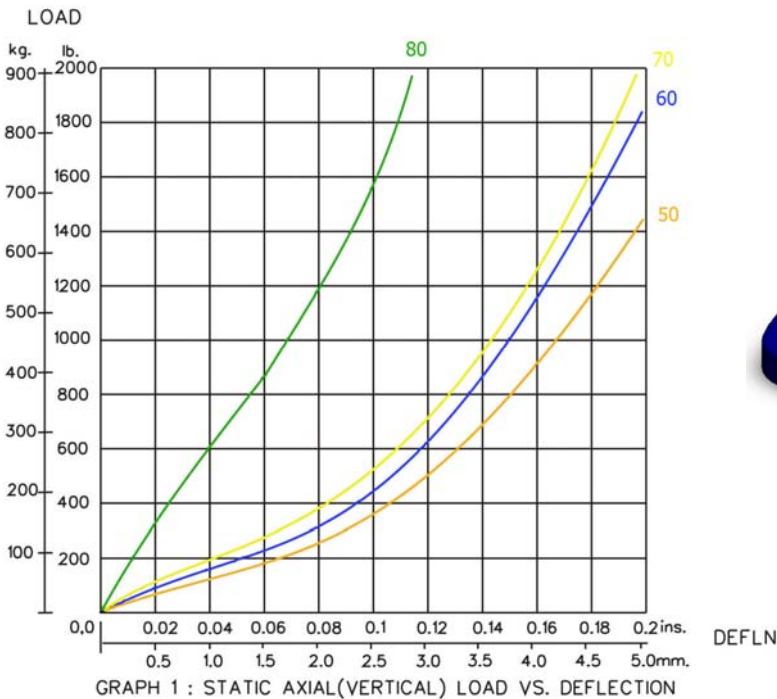

Poly Flex © 2009
PRODUCTS
DRAWING No. P#8.5FGEN24
DRAWN OK. 08.07.09