

DATA SHEET

MATERIAL SPECIFICATION
* ENGINEERING GRADE HEAT CURED POLYMER ALLOY
* ALL METAL PARTS - GOLD PASSIVATED ZINC PLATED

PRODUCT: MOUNT P-SYSTEM[®]
MODEL: P#8F80-20-16

IDENTIFICATION SYSTEM				
P# <u> </u> F <u> </u> <u> </u> <u> </u> - <u> </u> <u> </u> - <u> </u> <u> </u> (<u> </u>)				
BASE TYPE	CORE DIA.	CORE HEIGHT	THREAD SIZE	CORE HARDNESS

CORE COLOUR	SHORE HARDNESS
ORANGE	50
BLUE	60
YELLOW	70

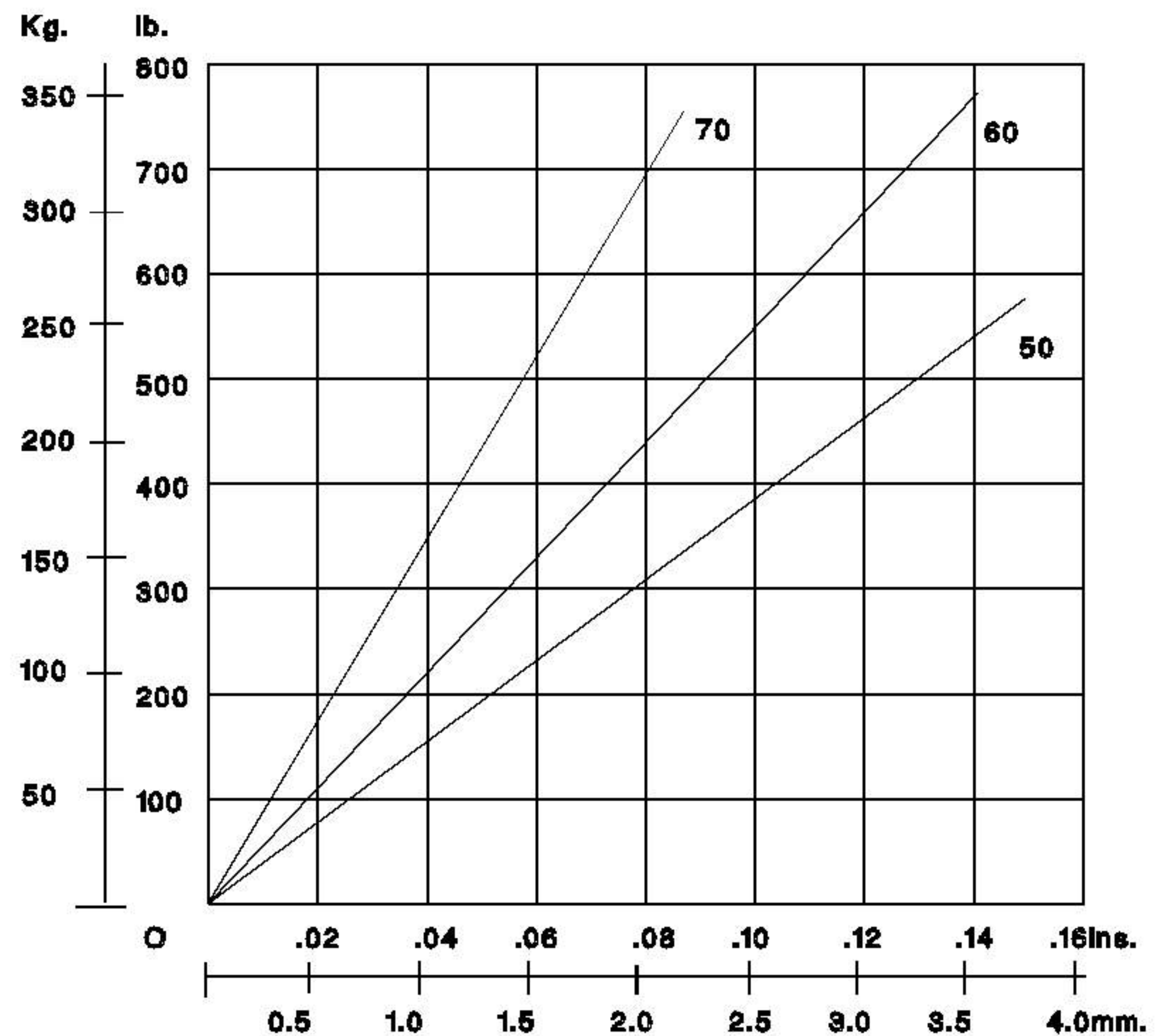
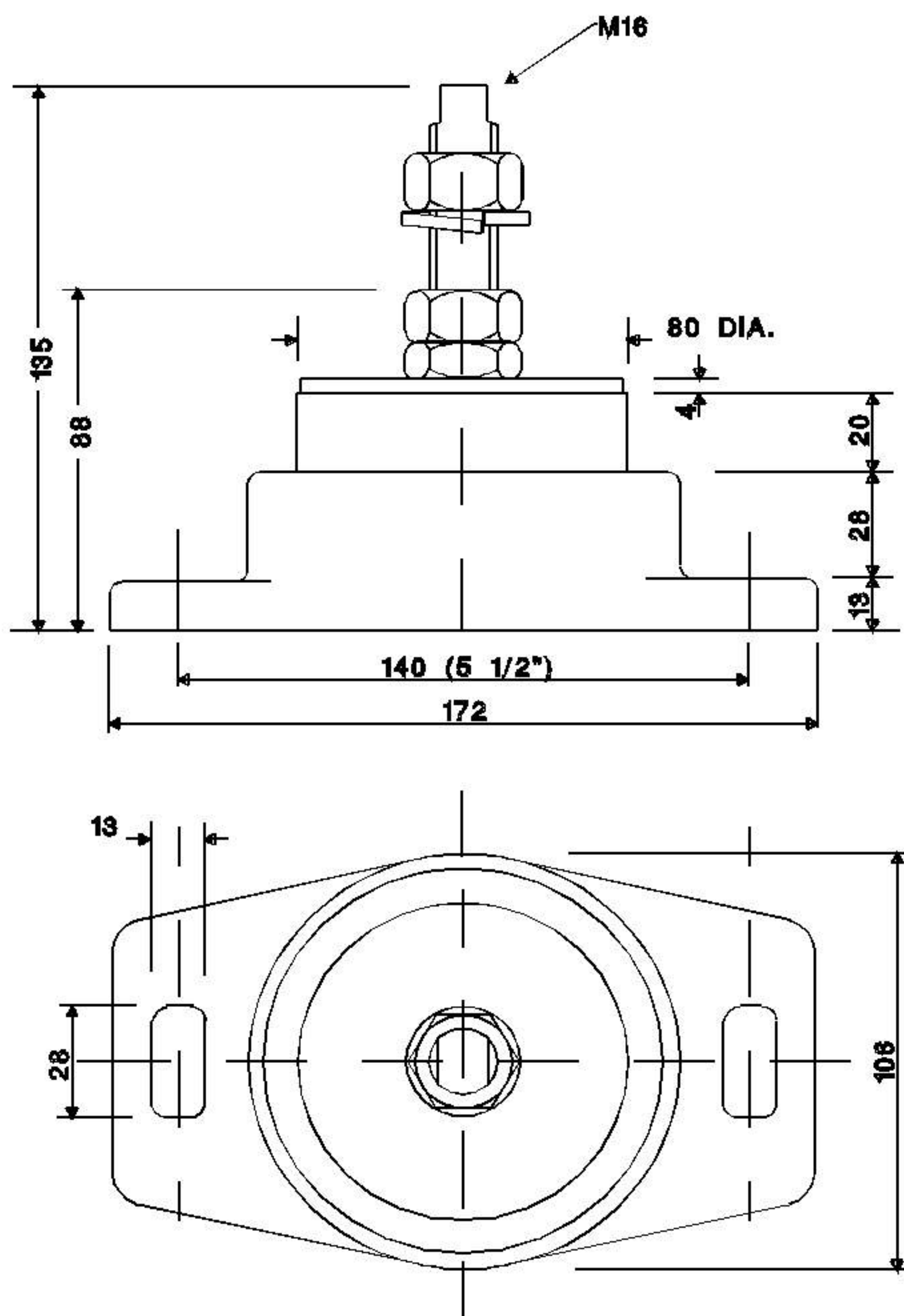

GRAPH : STATIC LOAD VS. DEFLECTION