

POLY FLEX DATA SHEET

PRODUCT: MOUNT P-SYSTEM[®]

SERIES: 5F SERIES[®]

MODEL: P#4.5 F60-11-12 ()

MATERIAL SPECIFICATION

- ENGINEERING GRADE HEAT CURED POLYMER ALLOY
- ALL METAL PARTS - SA5 COBALT ZINC PLATED

CORE COLOUR	SHORE HARDNESS
ORANGE	50
BLUE	60
YELLOW	70
GREEN	80

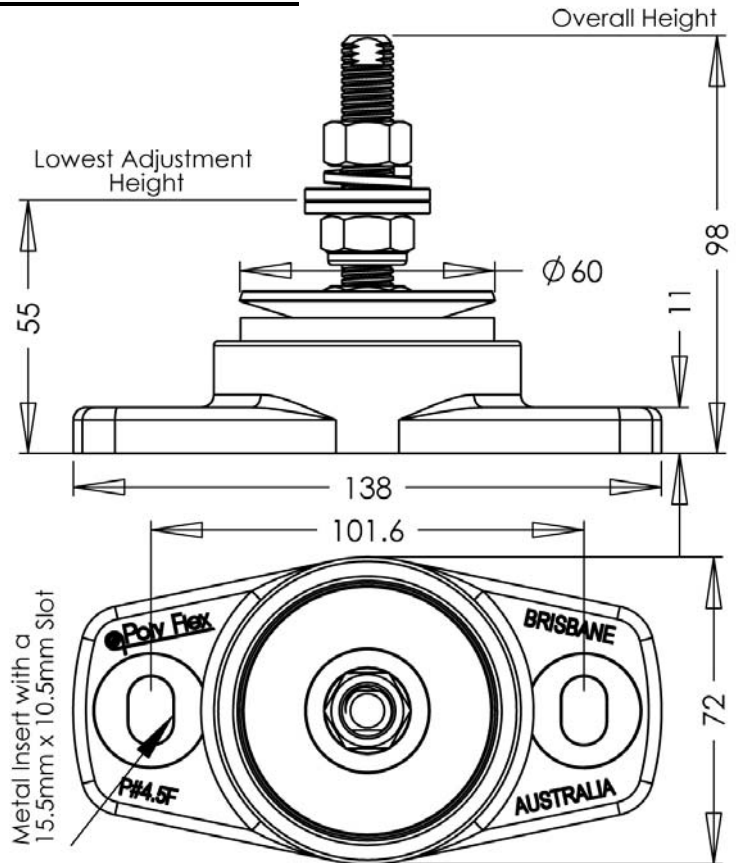

THE FOLLOWING DATA IS SUPPLIED AS A GUIDE ONLY.
PRODUCT SPECIFICATIONS AND DATA SHEETS ARE SUBJECT TO CHANGE WITHOUT NOTICE.

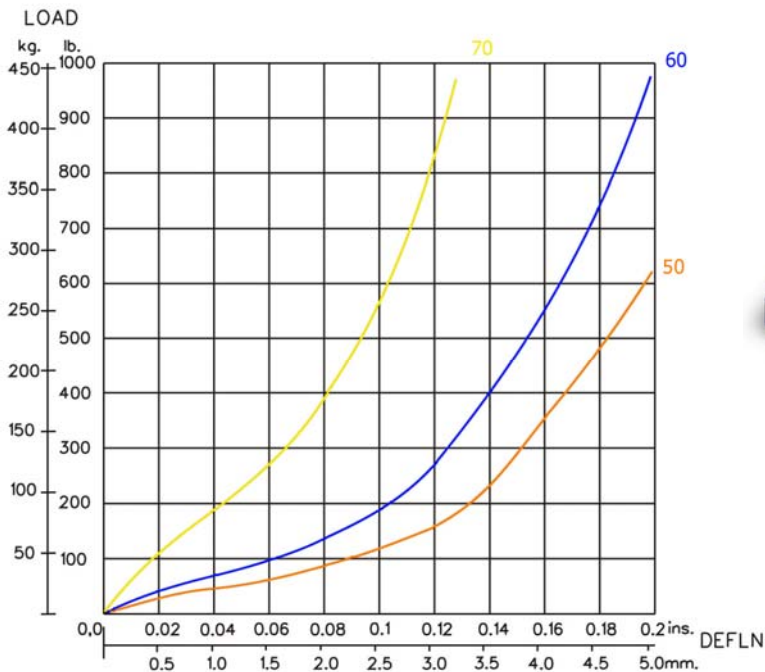

GRAPH 1 : STATIC AXIAL(VERTICAL) LOAD VS. DEFLECTION

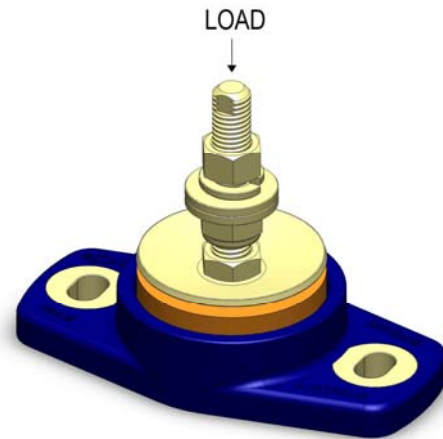

Poly Flex © 2009
PRODUCTS
DRAWING No. P#4.5F60-12
DRAWN OK. 22.06.09