

POLY FLEX DATA SHEET

PRODUCT: MOUNT P-SYSTEM[®]

SERIES: 5CTF SERIES[®]

MODEL: P#4.5 CTF60-15-14 ()

MATERIAL SPECIFICATION	
• ENGINEERING GRADE HEAT CURED POLYMER ALLOY	
• ALL METAL PARTS – SA5 COBALT ZINC PLATED	

CORE COLOUR	SHORE HARDNESS
ORANGE	50
BLUE	60
YELLOW	70
GREEN	80

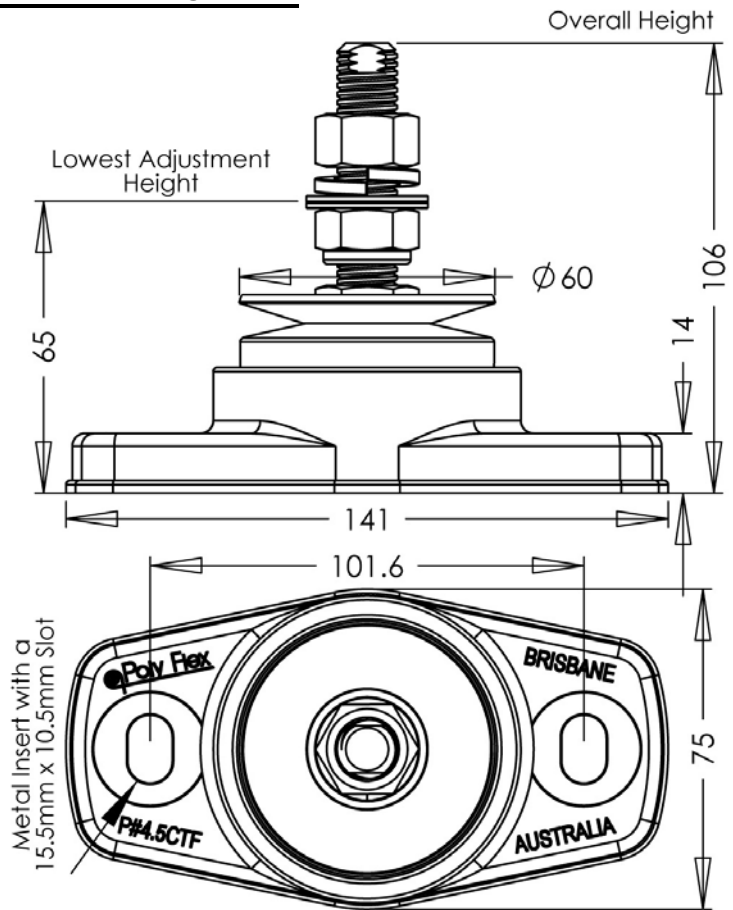

THE FOLLOWING DATA IS SUPPLIED AS A GUIDE ONLY. PRODUCT SPECIFICATIONS AND DATA SHEETS ARE SUBJECT TO CHANGE WITHOUT NOTICE.

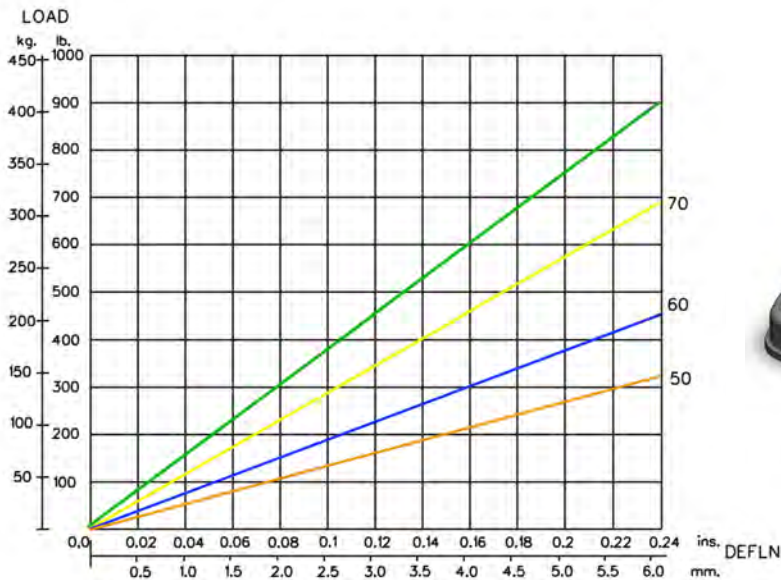

GRAPH 1 : STATIC AXIAL (VERTICAL) LOAD VS. DEFLECTION

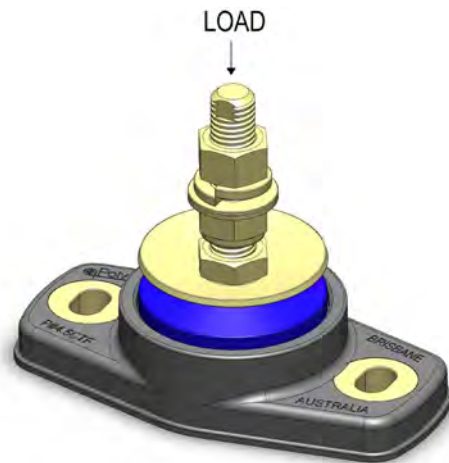

Poly Flex © 2009
PRODUCTS

DRAWING No. P#4.5CTF60-14
DRAWN OK. 21.07.09